



Frontier™ Centrifuge FC5513 & FC5513R Instruction Manual



Front and rear view of the centrifuge FC5513

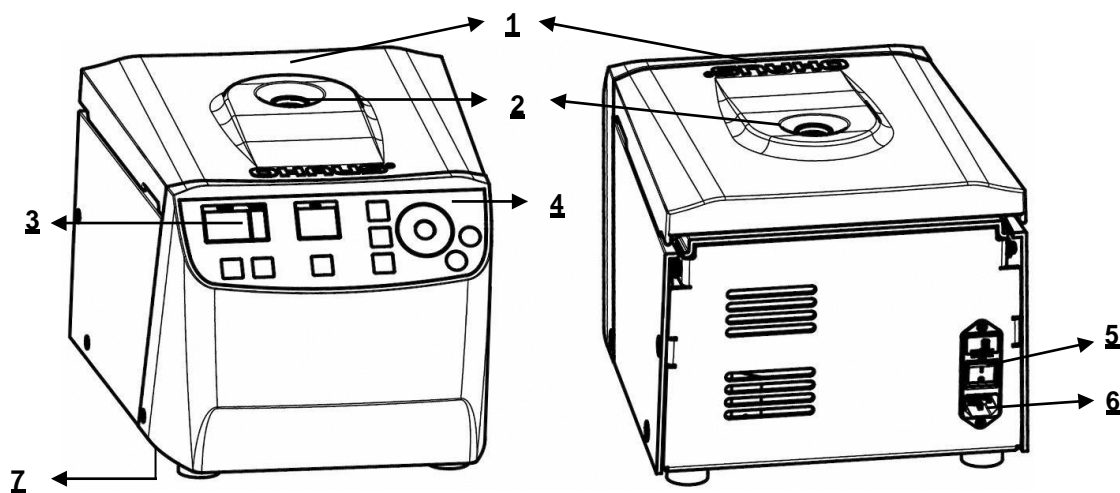

Figure.1

Front and rear view of the centrifuge FC5513R

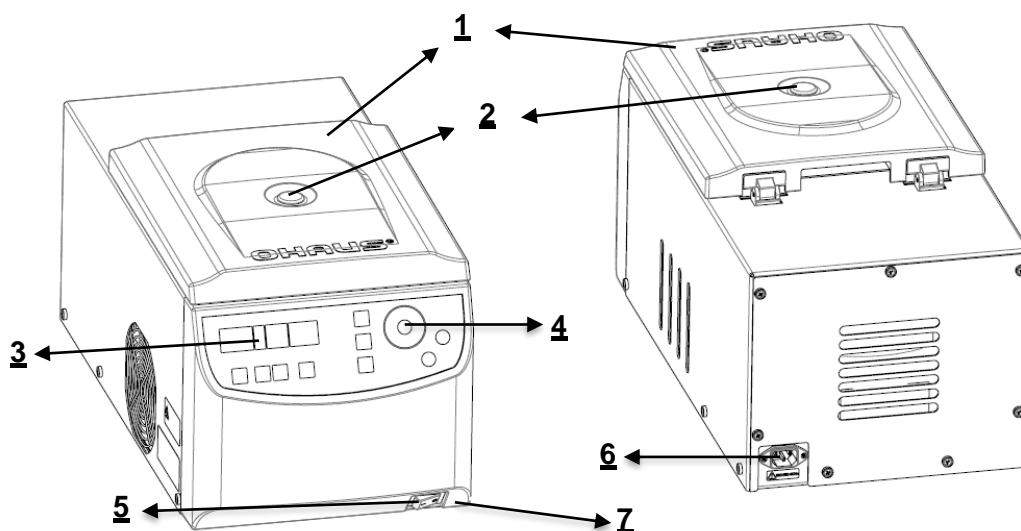

Figure.2

1 Centrifuge Lid	2 Rotor Window
3 Display	4 Function Label
5 Main Power Switch	6 Power Connection
7 Emergency Release	

Function Label

Function Label for FC5513



Figure.3

Function Label for FC5513R

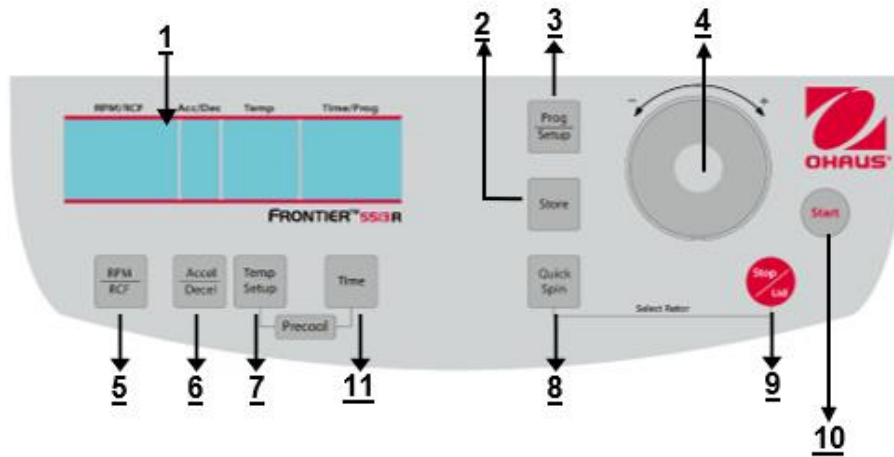

Figure.4

1 LCD Display	2 Store setup information
3 Program setup model	4 Adjusting Dial: Change the number
5 RPM/RCF model and select	6 Acceleration/Deceleration intensity model and select
7 Temperature setup model (Only FC5513R)	8 Short/quick spin centrifugation
9 Stop centrifugation / Release lid	10 Start centrifugation
11 Time setup model	

LCD Display

The following picture shows the individual elements of the LCD-display.

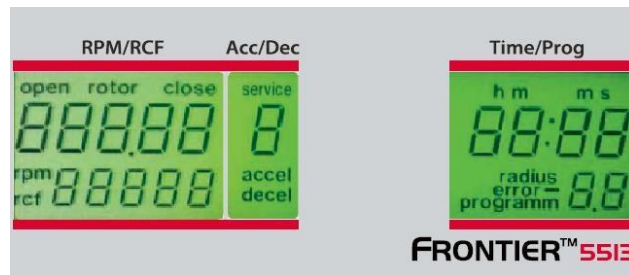

Figure.5

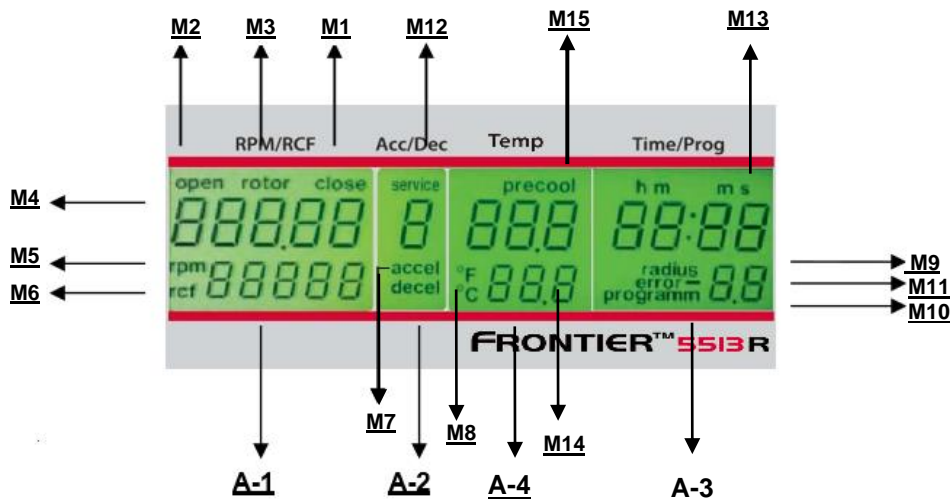

Figure.6

Display fields:

- A-1 Display fields – "RPM/RCF"
- A-2 Display fields – "Acc/Dec" "Service"
- A-3 Display fields – "Time/Prog"
- A-4 Display fields – "Temp"

Messages/logos of the display fields

M1	"close"	M2	"open"	M3	"rotor"
M4	"rotor no"	M5	"rpm"	M6	"rcf"
M7	"accel"	M8	"decel"	M9	"radius"
M10	"program"	M11	"error"	M12	"service"
M13	"h m s"	M14	"temperature"	M15	"precool"

Rotor No. Table

Rotor No. display	Order No.	Capacity	Fit model
02	30472302	Rotor Angle 24x1.5/2.0ml BIOSEALS V1	FC5513 and FC5513R
04	30472304	Rotor Hematocrit 24xCapillaries V1	FC5513
06	83041006	Rotor Angle 18x1.5/2.0ml Sealable	FC5513R
14	83041014	Rotor Angle 4x8-Place PCR Stripes V1	FC5513 and FC5513R
98	30210898	Rotor Angle 24x2.0ml Spin Column	FC5513

TABLE OF CONTENTS

1. INTRODUCTION	3
1.1 Description	3
1.2 Features	3
1.3 Definition of Signal Warnings and Symbols	3
1.4 Safety Precautions	4
1.4.1 User	4
1.4.2 Rotor and accessories	4
1.4.3 Measures for your protection	4
1.4.4 Exclude the following environmental influences	4
1.4.5 Measures for operational safety	5
1.4.6 Danger and precautions	5
1.4.7 Abbreviations used in this manual	5
2. INSTALLATION	6
2.1 Unpacking	6
2.1.1 Delivery package for Frontier™ FC5513	6
2.1.2 Delivery package for Frontier™ FC5513R	6
2.2 Selecting the Location	6
2.3 Installation	6
2.4 Safety precautions during operation	7
3. OPERATION	8
3.1 Mounting and loading rotor	8
3.1.1 Installation of rotors	8
3.1.2 Loading angle rotors	9
3.1.3 Loading and overloading of rotors	9
3.1.4 Removing the rotor	9
3.1.5 Power switch and fuse	9
3.2 Lid control	10
3.2.1 Lid open	10
3.2.2 Lid lock	10
3.3 Preselection	10
3.3.1 Preselection of speed / RCF-value	10
3.3.2 Preselection of running time	11
3.3.3 Preselection of brake intensity and acceleration	12
3.3.4 Pre-selection of temperature (Only FC5513R)	12
3.3.5 Pre-cooling (Only FC5513R)	12
3.4 Radius correction	13
3.5 Program	13
3.5.1 Storage of programs	13
3.5.2 Recall of stored programs	14
3.5.3 Leaving program mode	15
3.6 Starting and stopping the centrifuge	15
3.6.1 Starting the centrifuge	15
3.6.2 The "STOP/Lid" key	15
3.7 Imbalance detection	16
4. SETTING	17
4.1 Basic adjustments	17
4.1.1 Change the type of rotor	17
4.1.2 Access to mode "Operating Data"	17
4.1.3 Signal turn on / off	18
4.1.4 Keyboard sound turn on / off	19
4.1.5 Sleep Mode On / Off	19
4.1.6 Call up operating data	19
5. MAINTENANCE	21
5.1 Maintenance and cleaning	21
5.1.1 General Care	21
5.1.2 Cleaning and disinfection of the unit	21
5.1.3 Cleaning and disinfection of the rotor	21
5.1.4 Disinfection of aluminum rotors	22
5.1.5 Disinfection of PP-rotors	22
5.1.6 Glass breakage	22
6. TROUBLESHOOTING	23
6.1 Error message: Cause / Solution	23

6.2	Survey of possible error messages and their solutions.....	23
6.2.1	Lid release during power failure (Emergency Lid Release)	23
6.2.2	Description of the error message system	23
7.	RECEIPT OG CENTRIFUFES TO REPAIR	24
8.	TRANSPORT AND STORAGE	25
8.1	Transport.....	25
8.2	Storage	25
9.	TECHNICAL DATA.....	26
9.1	Specifications.....	26
9.1.1	Centrifuge FC5513.....	26
9.1.2	Centrifuge FC5513R.....	27
9.2	Drawings and dimensions.....	28
10.	ORDER INFORMATION.....	29
11.	COMPLIANCE.....	29
12.	APPENDIX.....	30
12.1	Table 1: Permissible net weight.....	30
12.2	Table 2: Max. speed and RCF-values for permissible rotors	30
12.3	Table 3: Lowest temperatures at max. speed	30
12.4	Table 4: Acceleration and deceleration times	31
12.5	Table 5: Error messages	32
12.6	Table 6: Radius correction.....	33
12.7	Table 7: Symbols- / Abbreviations	33
12.8	Table 8: Redemption form / Decontamination certificate	34

1. INTRODUCTION

1.1 Description

Thank you for choosing this OHAUS product.

All symbols indicate safety instructions and points to potentially dangerous situations. Please read the manual completely before using the Frontier™ FC5513 & FC5513R to avoid incorrect operation.

Frontier™ FC5513 & FC5513R centrifuge was designed for the separation of materials or mixtures with different density.

1.2 Features

The Frontier™ FC5513 & FC5513R centrifuge offers many practical features such as:

- High performance, reach up to 17,317 x g
- Rotor options for microtubes, spin column kit, and capillaries
- Remarkably small footprint to save invaluable benchtop space
- Ergonomic touch-wheel makes parameter adjustment fun
- Splash-proof front panel can endure sample spill and is easy to clean
- Distinct Intuitive control panel interface can be operated by one hand
- All key parameters are visible at all times

1.3 Definition of Signal Warnings and Symbols

Safety notes are marked with signal words and warning symbols. These show safety issues and warnings. Ignoring the safety notes may lead to personal injury, damage to the instrument, malfunctions, and false results.

The degree of danger is a part of a safety note and distinguishes the possible results of non-observance from each other.

Signal Words

DANGER	Will lead to severe injuries or death if not avoided.
WARNING	For a hazardous situation with medium risk, possibly resulting in injuries or death if not avoided.
CAUTION	For a hazardous situation with low risk, resulting in damage to the device or the property or in loss of data, or injuries if not avoided.
ATTENTION	For important information about the product. May lead to equipment damage if not avoided
NOTE	For useful information about the product

Warning Symbols



General Hazard



Electrical Shock Hazard

Alternating Current



Biohazard



Explosion



Crushing

Warning and information signs on the surface of centrifuge

Warning
Four carrier must be used at all times on four place swing out rotors or damage will occur to the centrifuge. Such damage will not be covered under the product warranty.

Four carrier must be used at all times on four place swing out rotors or damage will occur to the centrifuge. Such damage will not be covered under the product warranty.

Attention!!
Check the fastening of the rotor nut before each run.
Achtung!!
Vor jedem Lauf Befestigungsschraube auf festen Sitz pruefen.

Attention! Check the fastening of the rotor nut before each run.

Vor manueller Entriegelung oder öffnen des Gehäuses Netzstecker Ziehen!

Take off mains plug before opening the housing or the emergency release.

TAKE OFF MAINS PLUG before opening the housing or the emergency release!

RETIREZ LE CORDON avant toute intervention a l'interieur de l'appareil

 **230 V/50-60 Hz**

Power Input



Direction of Rotation – clockwise rotation for the rotor drive (only FC5513R)

1.4 Safety Precautions

1.4.1 User

OHAUS centrifuges are intended exclusively for indoor use and for use by qualified personnel. This device may only be operated by trained specialist staff. They must have carefully read the operating manual and be familiar with the function of the device.

1.4.2 Rotor and accessories

Only OHAUS original rotors and accessories shall be used. Any other use or intended use is considered improper. OHAUS is not liable for damage resulting from improper use.



CAUTION:

Read all safety warnings before installing, making connections, or servicing this equipment. Failure to comply with these warnings could result in personal injury and/or property damage. Retain instructions for future reference.

1.4.3 Measures for your protection



WARNING: Never work in an environment subject to explosion hazards! The housing of the instrument is not gas tight. (Explosion hazard due to spark formation, corrosion caused by the ingress of gases)



WARNING: When using chemicals and solvents, comply with the instructions of the producer and the general lab safety rules.



WARNING: The centrifuge is not sealed. Use suitable protection measures when using the centrifuge for infectious and pathogenic samples. Follow appropriate safety precautions when handling these samples.

1.4.4 Exclude the following environmental influences

- Powerful vibrations
- Direct sunlight
- Atmospheric humidity greater than 80%
- Corrosive gases present
- Temperatures below 2 °C and above 35 °C
- Powerful electric or magnetic fields:



WARNING:

Electrical shock hazards exist within the housing. The housing should only be opened by authorized and qualified personnel. Remove all power connections to the unit before opening.

1.4.5 Measures for operational safety

- Do not unscrew the two halves of the housing
- Dry off any liquid spills immediately! The instrument is not watertight
- Verify that the equipment's input voltage range and plug type are compatible with the local power supply.
- Only connect the power cord to a properly grounded power receptacle.
- Only use a power cord with a rating that exceeds the specifications on the equipment label.
- Do not position the equipment such that it is difficult to disconnect the power cord from the power receptacle.
- Make sure that the power cord does not pose a potential obstacle or tripping hazard.
- The equipment is for indoor use only. Use the equipment only in dry locations.
- Use only approved accessories.
- Operate the equipment only under ambient conditions specified in these instructions.
- Disconnect the equipment from the power supply when cleaning.
- Do not operate the equipment in hazardous or unstable environments.
- Service should only be performed by authorized personnel.

1.4.6 Danger and precautions

To protect people and environment the following precautions should be observed:

- During centrifugation, the presences of people are prohibited within 30 cm around the centrifuge according to the regulations of EN 61010-2-020.
- FC5513& FC5513R are not explosion-proof and must therefore not be operated in explosion-endangered areas or locations. Centrifugation of flammable, explosive, radioactive, or such substances, which chemically react with high energy, is strictly prohibited. The final decision on the risks associated with the use of such substances is the responsibility of the user of the centrifuge.
- Never spin toxic or pathogenic material without adequate safety precautions, i.e. centrifugation of buckets / tubes with missing or defective hermetic sealing is strictly prohibited. The user is obliged to perform appropriate disinfection procedures in case dangerous substances have contaminated the centrifuge and or its accessories. When centrifuging infectious substances, always pay attention to the general laboratory precautions. If necessary, contact your safety officer!
- It is prohibited to run the centrifuge with rotors other than listed for this unit.
- Under no circumstances open the lid of the centrifuge while the rotor is still running or rotating with a speed of >2m/s.

1.4.7 Abbreviations used in this manual

Symbol/Abbreviations	Unit	Description
RPM	[min ⁻¹] rpm	revolutions per minute
RCF	[x g]	relative centrifugal force
PCR		PCR Polymerase chain reaction
PP	-	Polypropylene
PC	-	Polycarbonate
accel	-	acceleration
decel	-	deceleration
prog	-	program

2. INSTALLATION

2.1 Unpacking

Carefully remove your centrifuge and each of its components from the package. The included components vary depending on the centrifuge model (see table below). Save the packaging to ensure safe storage and transport. The instruction manual must always be kept with the centrifuge!

Rotor(s) / Accessories will be packed separately.

2.1.1 Delivery package for Frontier™ FC5513

Quantity	Description
1	Centrifuge FC5513
1	Power Cable
1	Warranty Card
1	Instruction Manual
1	Rotor Key
1	Rotor Nut

2.1.2 Delivery package for Frontier™ FC5513R

Quantity	Description
1	Centrifuge FC5513R
1	Power Cable
1	Warranty Card
1	Instruction Manual
1	Rotor Key
1	Rotor Nut

2.2 Selecting the Location



ATTENTION:

Avoid excessive vibrations, heat sources, air current, or rapid temperature changes.

- The centrifuge should be installed on an even, solid and level surface, if possible, on a laboratory cabinet / table or some other solid vibration free surface.
- During centrifugation, the centrifuge must be placed in a way, that there is a minimum space of 30 cm on each side of the unit, according to the standards EN 61010-2-020.
- Do not place the centrifuge next to a window or a heater, where it could be exposed to excessive heat, as the performance of the unit is based on an ambient temperature of 23 °C.

2.3 Installation

Follow these steps:

- Check whether the power supply corresponds with the one specified on the manufacturer's rating label, which is located on the rear panel.
- The line voltage circuit breaker is max. 10 A (type K) slow release for commonly used instruments.
- In case of emergency, there must be an emergency switch off installed outside the room in order to disconnect the power supply from the unit.
- Connect the centrifuge to a grounded power receptacle.
- Turn the instrument on, by using the mains power switch.
- Open the lid by using the Stop / Lid button.
- Remove the transport securing device of the motor.

2.4 Safety precautions during operation

- Do not operate the centrifuge in case it is not installed correctly.
- Do not lean on the centrifuge during operation.
- Do not stay within the 30 cm clearance envelope longer than necessary for operational reasons.
- Do not place any potentially hazardous materials within the 30 cm clearance envelope.
- Do not operate the centrifuge when disassembled (e.g. without housing).
- Do not run the centrifuge when mechanical or electrical components have been tampered with.
- Do not use accessories such as rotors and buckets, which are not exclusively approved by OHAUS Corporation, except commercially available centrifuge tubes made of glass or plastic.
- Do not spin extremely corrosive substances, as they may damage or weaken the materials.
- Do not operate the centrifuge with rotors or buckets, which show any signs of corrosion or mechanical damage.

The manufacturer is responsible for safety and reliability of the centrifuge, only if:

- The unit is operated in accordance with this instruction manual.
- Modifications, repairs, or other adjustments are performed by authorized personnel and the electrical installation complies with the relevant electrical codes.

3. OPERATION

3.1 Mounting and loading rotor

3.1.1 Installation of rotors

For FC5513 centrifuge packaged with rotor already installed, these following steps are not necessary.

Clean the drive shaft as well as the collet with a clean, grease-free piece of cloth. Place the rotor onto the drive shaft. (see figure below). Take care that the rotor is fully installed onto the motor shaft.



Figure.7



Figure.8-1



Figure.8-2



Figure.8-3



Figure.8-4

The rotors have to be locked with provided rotor key. Therefore, hold the rotor with one hand and secure the rotor by turning the fixing nut clockwise (see figures 8)

We will provide a tool for nut-nut rotor with centrifuge.



ATTENTION:

Check that the fixing screw is properly installed before each run. (see figures 8)

Do not operate the centrifuge with rotors or buckets which show any signs of corrosion or mechanical damage.

Do not operate with extremely corrosive substances, which could damage the rotor, buckets, and materials.

In case of any questions, please contact the manufacturer!

3.1.2 Loading angle rotors

Rotors must be loaded symmetrically and with equal weight (see figure below). The adapter may only be loaded with the appropriate vessels. The weight differences between the filled vessels should be kept as low as possible. Therefore, we recommend weighing them with a balance. This reduces the wear of the drive and the acoustic operating noise.

On each rotor, the maximum load per hole is stated.



Figure.9 WRONG



Figure.10 CORRECT (12 tubes)

3.1.3 Loading and overloading of rotors

All approved rotors are listed with their maximum speed and maximum filling weight in "table 2 permissible net weight" (See APPENDIX).

The maximum load permitted for a rotor, which is determined by the manufacturer, as well as the maximum speed allowed for this rotor (See label on rotor), must not be exceeded. The liquids the rotors are loaded with, should have a maximum homogeneous density of 1.2 g/ml or less when the rotor is running at maximum speed.

In order to spin liquids with a higher density, the speed has to be reduced according to the following formula:

$$\text{Reduced speed } n_{\text{red}} = \sqrt{\frac{1,2}{\text{higher density}}} \times \text{max. speed } (n_{\text{max}}) \text{ of the rotor}$$

Example:

$$n_{\text{red}} = \sqrt{\frac{1,2}{1,7}} \times 4.000 = 3.360 \text{ rpm}$$

If in case of any questions, please contact the manufacturer!

3.1.4 Removing the rotor

Untighten the rotor fixing nut completely (screw over the stiff point) and lift the rotor vertical out of the centrifuge. (see figure 8).

3.1.5 Power switch and fuse

The power switch is located on the back side or in the front of the centrifuge (see figure 11).



ATTENTION: After turning on the power switch, open the centrifuge lid first, before starting the centrifuge



Fuse drawer with fuse 4 AT

Figure.11-1 Power Switch and Fuse (FC5513)



Figure.11-2 Power Switch (FC5513R)

3.2 Lid control

3.2.1 Lid open

Before the run, when the lid of the centrifuge is closed, the word **"close"** (M1) appears in the display **"RPM | RCF"** (A-1). Additionally, the code number of the preset rotor is shown in the display. Even if the rotor is not inserted. By pressing the key **"Stop/Lid"** (9) you can release the lid of the centrifuge. As soon as the lid is completely released, the word **"open"** (M2) appears. Now you can open the lid of the centrifuge. Please refer to figure 12 below for reference.

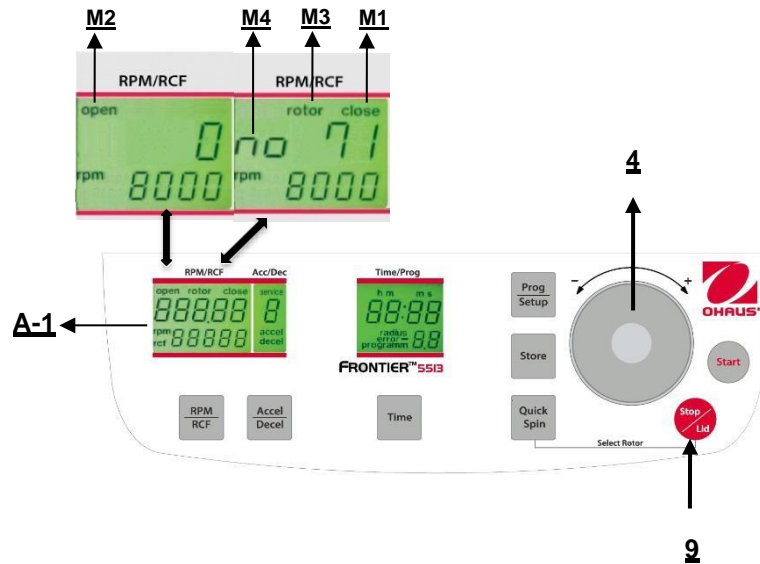

Figure. 12

During the run you can call up the rotor type at any time by pressing the key **"Stop/Lid"** (9).

3.2.2 Lid lock

The lid should only be put down slightly. A lid lock closes the lid, at the same time the word **"open"** (M2) disappears (refer to figure 15).

As a sign that the centrifuge is ready for starting, in the display **"RPM | RCF"** (A-1) the word **"close"** (M1) appears. Simultaneously the word **"rotor"** (M3) is displayed, as well as the code number of the rotor, which is in the centrifuge system, **"no 71"** (M4). With that, all rotor specific data, like e. g. max. speed, acceleration etc., are adopted.



ATTENTION:

Don't grip your fingers between lid and device or locking mechanism when closing the lid!
Before closing the lid, please check if the rotor is tightened.

3.3 Preselection

3.3.1 Preselection of speed / RCF-value

This pre-selection is activated through the key **"RPM/RCF"** (5) (refer to figure 13 below). By pressing the key once the word **"rpm"** (M5) flashes. By pressing the key twice, the pre-selection of the centrifugal forces can be selected. Then the flashing word **"rcf"** (M6) appears. You can set the desired values with the adjusting dial (1). In the display (A-1) the regulated value is shown permanently, before, during and after the run.

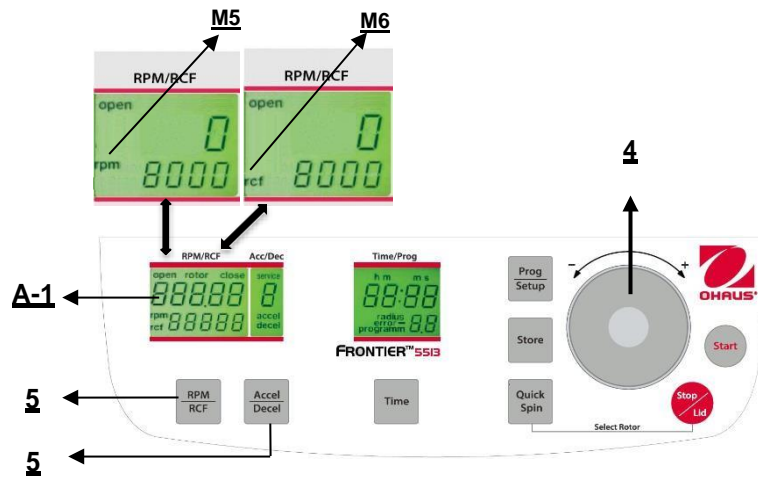

Figure. 13

As long as no rotor is inserted, the speed is adjustable between 200 rpm and maximum revolution of the centrifuge. If there is a rotor in the centrifuge the speed can only be pre-selected until the maximum permissible revolution of that rotor. It is the same with the pre-selection of the RCF-value. The setting range is between 20 x g and the maximum permissible centrifugal force of the rotor.

See **"Table 4: max. speed and RCF-values for permissible rotor"** (See APPENDIX). All-important values are listed there.

**ATTENTION:**

Please also check the maximum permissible revolutions of your test tubes with the manufacturer.

3.3.2 Preselection of running time

The running time can be pre-selected in three different ranges from 10 seconds up to 99 hours 59 minutes.

1. Range from 10 seconds up to 59 minutes 50 seconds in steps of 10 seconds
2. Range from 1 hour up to 99 hours 59 minutes in steps of 1 minutes
3. The continuous run "cont", which can be interrupted by the key "Stop/Lid"(9) (refer to figure 14).

The running time can be pre-selected with the lid open or closed.

To activate the setting of the running time, press the key "Time"(7).

In the display "Time/Prog" (A-3) flashes the indication "m : s" or "h : m", depending on the previous setting.

To set the desired value, use the adjusting dial (4). After exceeding 59 min 50 sec the indication changes automatically into "h : m". After exceeding 99 hours 59 min the word "cont" appears in the display "Time/Prog" (A-3). That continuous run can only be interrupted by pressing the key "Stop/Lid" (9). The time countdown starts as soon as the set speed is reached.

The display always shows the remaining running time. (see figure 14)

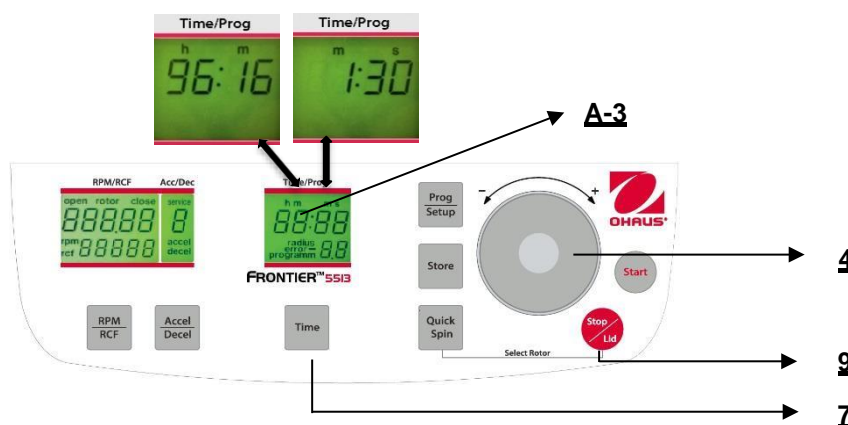

Figure. 14

3.3.3 Preselection of brake intensity and acceleration

This function is activated through the key "**Accel/Decel**" (6) (refer to figure 15).

By pressing the key once the word "**accel**" (M7) flashes in the display "**Acc/Dec**" (A-2). The desired acceleration can be pre-selected by the adjusting dial (4). The value 0 is equivalent to the lowest and the value 9 to the highest acceleration.

By pressing the key "**Accel/Decel**" (6) twice, the display "**Acc/Dec**" (A-2) indicates the word "**decel**"(M8). Now the desired brake intensity can be pre-selected by the adjusting dial (4). The value 9 is equivalent to the shortest and the value 0 to longest possible brake time.

See "**table 5: acceleration and deceleration times**" (APPENDIX). There the acceleration and deceleration times for the acceleration and deceleration stages 0 to 9 for permissible rotors are shown.

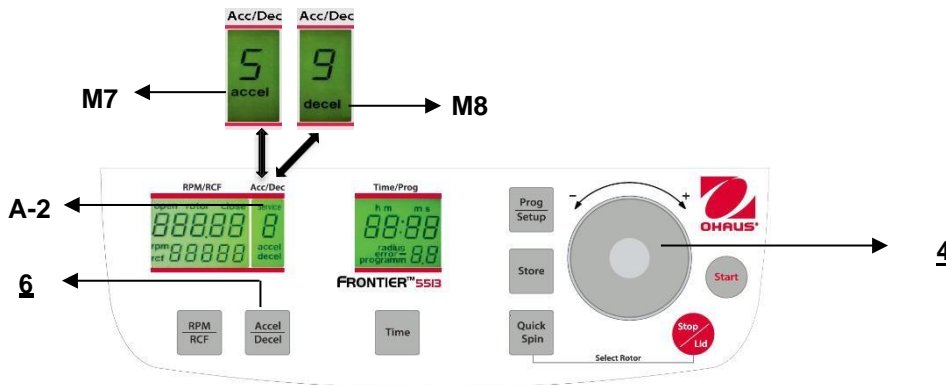

Figure. 15

3.3.4 Pre-selection of temperature (Only FC5513R)

This function is activated by the key "**Temp/Setup**" (13). After pressing this key in the display "**Time/Prog**" the indication "**°C**" (A-4) flashes. By the adjusting dial (4) the desired test temperature can be pre-selected in steps of 1°C in a range from -20°C up to +40°C.

The value is indicated permanently in the display (figure 16) - before, during and after the run. Please notice the respective lowest temperatures of the rotors at maximum speed!

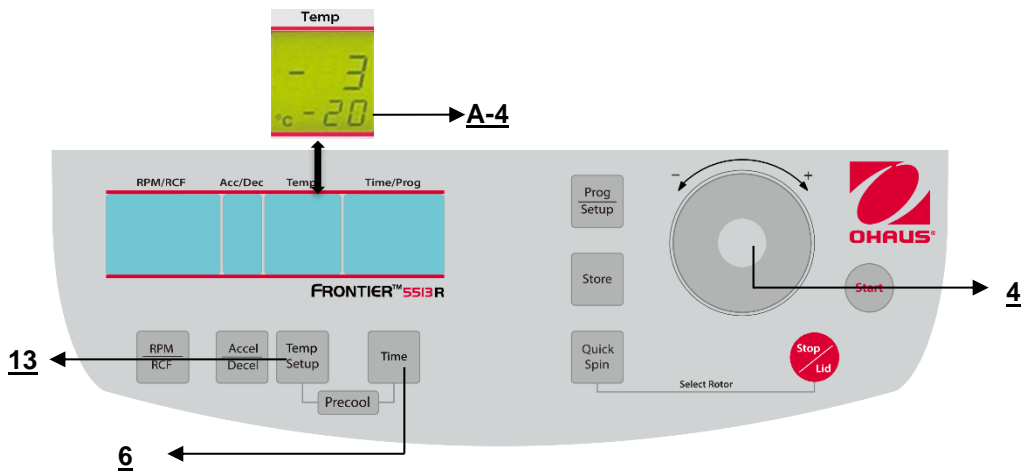

Figure. 16

3.3.5 Pre-cooling (Only FC5513R)

If the samples are temperature-sensitive it is useful to pre-cool the centrifuge, the rotor and eventually the buckets to the required working temperature. Therefore, insert the desired rotor and pre-set the respective temperature. By simultaneous pressing the keys "**Temp/Setup**" (13) (refer to figure 17) and "**Time**" (6) you start the run. While running, the unit chooses automatically a rotational speed that is equivalent to 20 % of the permitted rotational speed of the respective rotor. After the pre-set temperature is reached you can leave the pre-cooling run with the "**Stop**" key (9). Depending on the inserted rotor the pre-cooling goes between approx. 10 and 20 min.

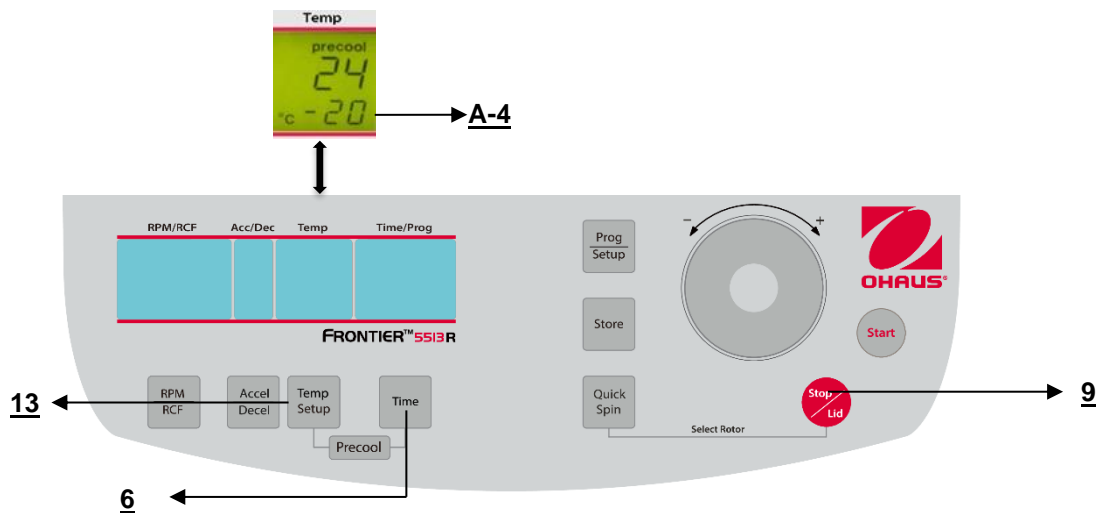

Figure. 17

3.4 Radius correction

If you use adapters or reducers, it could change the centrifugal radius of the respective rotor. In that case you can correct the radius manually. Please proceed as follows:

Close the lid, then press the key **"Time"** (7) (refer to figure 16) and the key **"Prog/Setup"** (3) at the same time and hold them.

In the display **"Time/Prog"** (A-4) the word **"radius"** (M9) appears. By the adjusting dial (4) you can preselect the respective radius correction (See Table 7, APPENDIX) in steps of 0.1 cm. As soon as you have set a radius correction the word **"radius"** (M9) appears. This word will be visible until you put the radius correction back to 0 again.

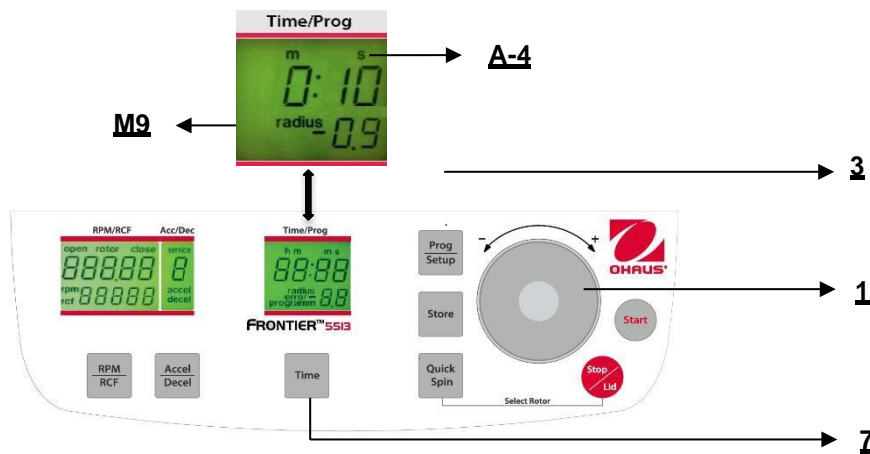

Figure. 18

3.5 Program

3.5.1 Storage of programs

You can store up to 99 runs with all relevant parameters, including the used rotors. You can use any free program number and call it up again.

Put the needed rotor into the centrifuge. By pressing the key **"Prog/Setup"** (3) in the display **"Time/Prog"** (A-3) the word **"programm"** (M10) appears. With the adjusting dial (4) you can chose the desired program number.

If a program number is already occupied, in the display **"RPM/RCF"** (A-1), the words **"rotor"** (M3) and **"xx"** (M4) will appear. In case of free program numbers, 0 appears

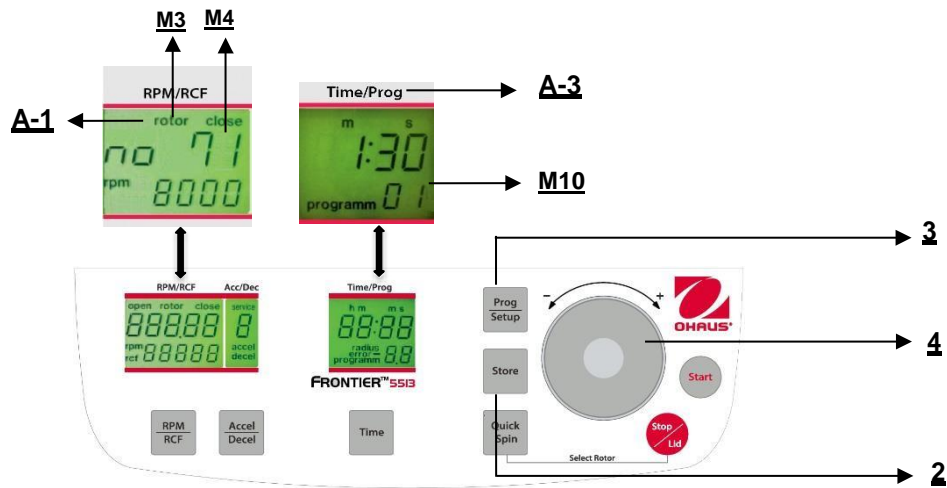

Figure. 19

Close the lid of the centrifuge. Now proceed as described previously to set all important run parameters. If the lid isn't closed when storing the program, in the display "RPM/RCF" (A-1), the words "FirSt" and "CLOSE Lid" (see figure 20) flashes alternately. If you want to start the run without storing the program, in the display "RPM/RCF" (A-1), the words "First" and "PrESS StoreE" (See figure 21) flashes alternately.

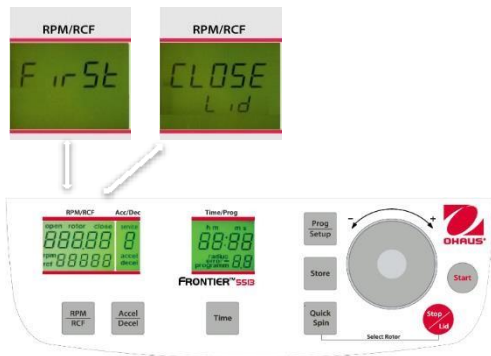

Figure. 20

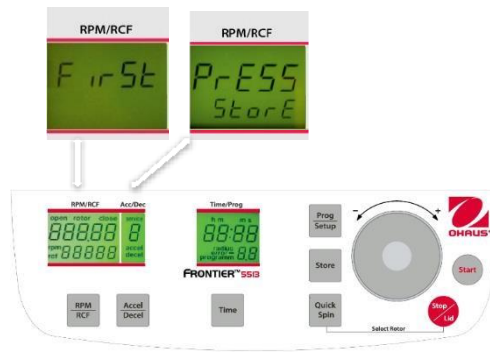

Figure. 21

For adaption of data press the key "Store" (2) (refer to figures 20 and 21) for approx. 1 second. If the program is stored correctly, the word "StorE" appears in the display "RPM/RCF" (A-1). As a result, the word "programm" (M10) disappears.

As soon as the key "Store" (2) is released, the word "programm xx" (M10) reappears – the (xx) stands for the chosen program location.

If all program numbers are occupied, you can take an old number that is not necessary anymore and just put in the new parameters.

3.5.2 Recall of stored programs

To recall stored programs, press the key "Prog/Setup" (3) (refer to figure 22) while the lid is already closed. Inside the display "Time/Prog" (A-4), "programm -" (M10) appears. The desired program number can be pre-selected with the adjusting dial (4).

In the respective displays the stored values for that program will appear.

If the wrong rotor is inside the centrifuge for the pre-selected program, in the display "RPM/RCF" (A-1), the word "rotor" (M3) flashes. At the same time the word "FALSE" and the stored rotor number "xx" (M4) will flashing by turns.

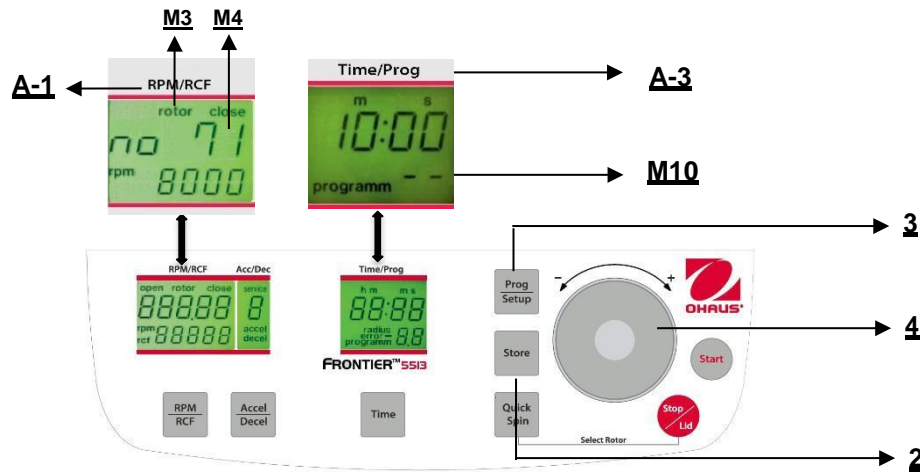

Figure. 22

3.5.3 Leaving program mode

To leave the program mode just press the key **"Prog/Setup"** (3) (refer to figure 22). Then inside the display **"Time/Prog"** (A-3) the word **"programm"** (M10) appears.

Set the display to **"programm--"** (M10) with the adjusting dial (4).

3.6 Starting and stopping the centrifuge

3.6.1 Starting the centrifuge

You can start the centrifuge either with the **"Start"** key (10) (refer to figure 21) or the **"Quick Spin"** key (8).

By the **"Start"** key (10) you can start stored runs or runs with manually pre-selected parameters.

When the respective pre-selected running time has ended the centrifuge will stop automatically.

By the **"Quick Spin"** key (8) you can start runs, which will last just a few seconds.

By pressing the **"Quick Spin"** key (8) the centrifuge accelerates up to the pre-selected revolution.

In the display **"Time/Prog"** (A-3) the passed running time is indicated from the date of pressing the **"Quick Spin"** key (8).

By releasing the **"Quick Spin"** key (8) the centrifuge stops and the running time is indicated until the opening of the lid.

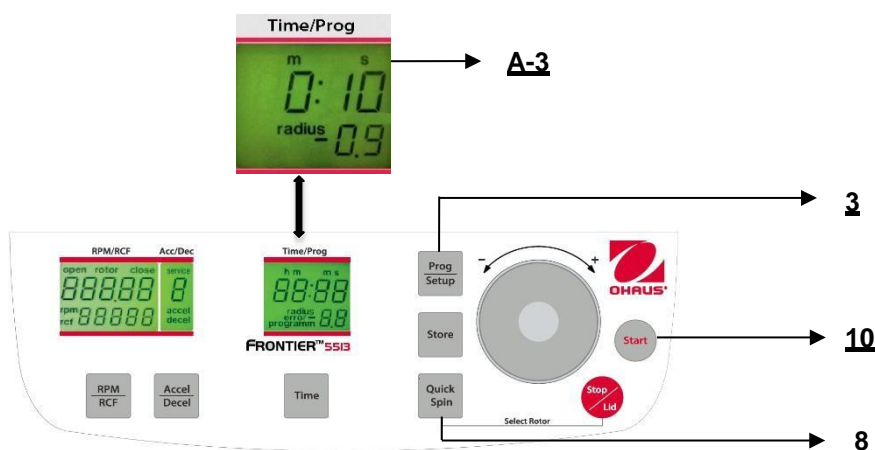

Figure. 23

3.6.2 The "STOP/Lid" key

By the **"Stop/Lid"** key (9) (see figure 24) you can interrupt the run at any time. After pressing the key, the centrifuge decelerates with the respective pre-selected intensity down to stand still. After the rotor complete stopped, press the "Stop/Lid" key will open the lid.

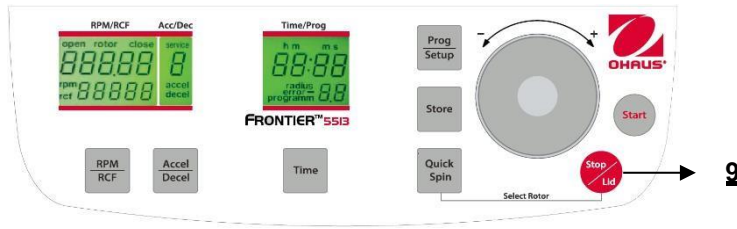

Figure. 24

3.7 Imbalance detection

In case of the rotor not being equally loaded, the drive will turn off during acceleration. The rotor decelerates to stand still.

When in the display **"Time/Prog"** (A-3) the word **"error"** (M11) together with the number **"01"** appear, the weight difference of the samples is too large. Distribute the weight evenly.

Load the rotor as described in chapter 3.1.2 and 3.1.3.

When inside the display **"Time/Prog"** (A-3) the word **"error"** together with the number **"02"** (see figure 25) appear, it could be due to the following reason: The imbalance sensor is defective.

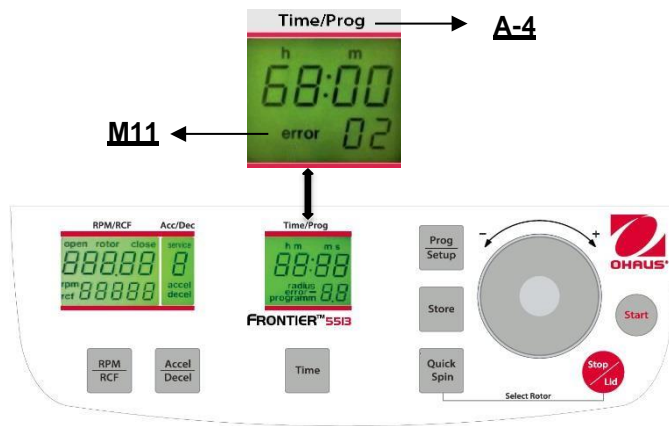

Figure. 25

4. SETTING

4.1 Basic adjustments

4.1.1 Change the type of rotor

Before the first operation and after each rotor change, you have to set the rotor type. You find each rotor type in the printed order number on the rotor.

Example:

Angle rotor order number: 30130871

Rotor Type on the display = 71

Turn on the centrifuge and open the lid. Now simultaneously press the keys "**Quick Spin**"(8) and "**Stop/Lid**"(9). In the display "**RPM/RCF**" the old rotor type no "**71**" appears. With the potentiometer you can now set the rotor type. To store the new setting please press the "**Start**" (10) key. Inside the display, "**Store**" appears as confirmation.

Now all-important rotor parameters for the centrifuge are stored.



ATTENTION:

The set rotor type must always be the same as the actual rotor type used; otherwise, the equipment might be damaged.

The rotor type can be checked during the run by pressing the key "**Quick Spin**"(8).

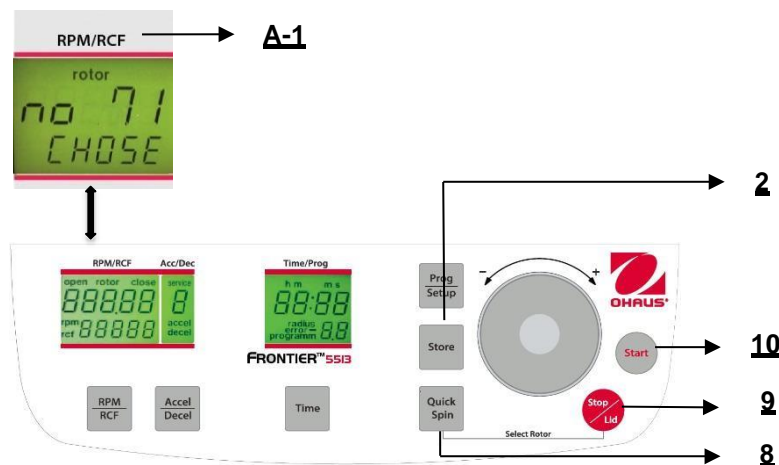

Figure. 26

4.1.2 Access to mode "Operating Data"

When using the centrifuge, the following parameters can be set:

- Temperature Indication in °C or °F (only FC5513R)
- Acoustic signal turn on/off
- Keyboard sound turn on/off
- Sleep Mode On / Off

The following operating data can be retrieved in this menu:

- Number of Starts
- Operating Hours of Centrifuge
- Operating Hours of Motor
- Software Version
- Error List
- Function of the Imbalance Sensor
- Operation of Keyboard
- Hardware Version
- Intermediate Circuit Voltage in Volt

While the centrifuge is turned off, press simultaneously the keys "**Time**"(7) and "**Stop/Lid**" (9) and turn on the mainswitch of the centrifuge. Now release both keys and as a result a display test is executed for approx. 5 seconds. All indicators will appear at the same time (see figure 27).

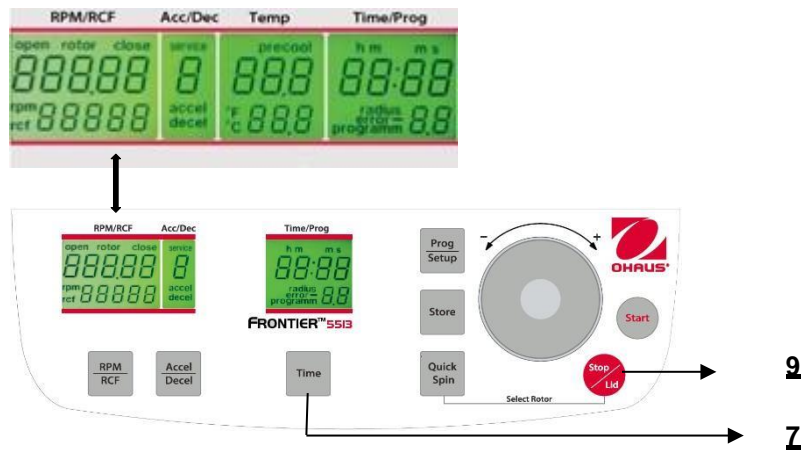

Figure. 27



ATTENTION:

Please notice that you must enter the program as described under point 4.1.2 to change the adjustments of the points 4.1.3 - 4.1.8. After you have stored the settings, you can change to normal program mode again by switching off the centrifuge for a short while.

All changed settings must be confirmed by the key **"Start"**(10). The word **"Store"** appears in the display **"RPM/RCF"(A-1)** - Only then the pre-selections are valid!

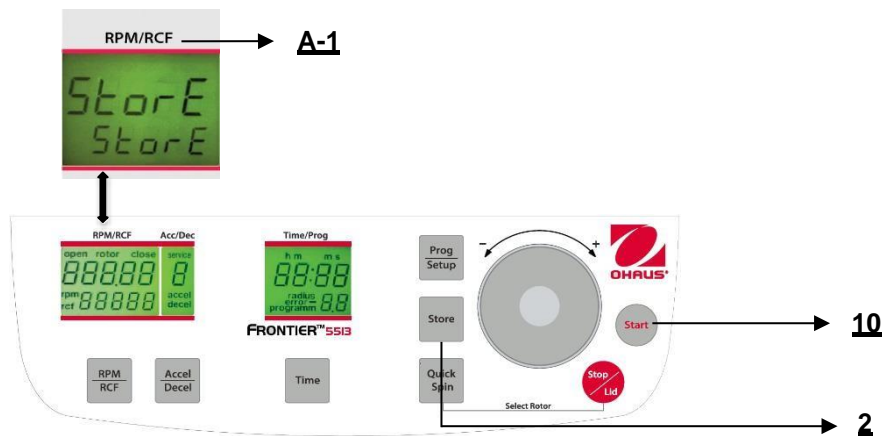

Figure. 28

4.1.3 Signal turn on / off

Proceed as described under point 4.1.2 to enter this program mode and then press the key **"Accel/Decel"** (6). In the display **"Acc/Dec"** (A-2) the word **"Service"** flashes. Now select the letter **"L"** with the adjusting dial (4). As a result, the words **"On Sound"** appears in the display **"RPM/RCF"** (A-1). If you press the key **"RPM/RCF"** (A-1) now, the word **"On"** flashes and you can switch off the sound with the adjusting dial (4) (see figure 29).

After you have stored the settings (see 4.1.2) you change back to the normal program mode again by switching off the centrifuge for a short while.

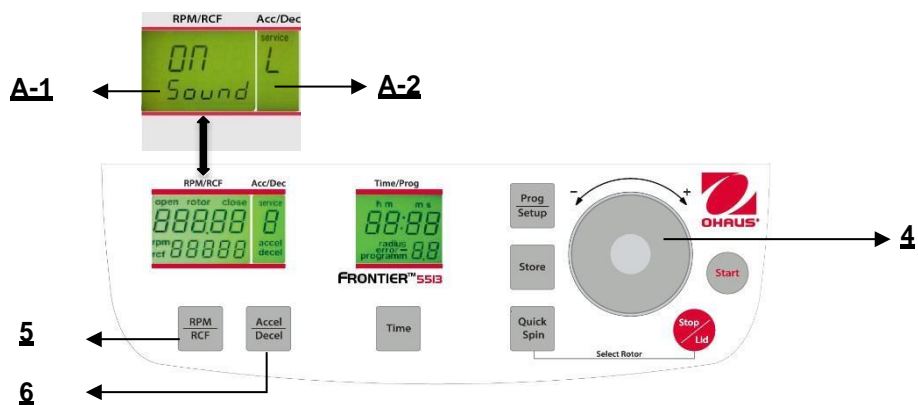

Figure. 29

4.1.4 Keyboard sound turn on / off

Proceed as described under point 4.1.2 to enter this program mode and then press the key "**Accel/Decel**" (6). In the display "**Acc/Dec**" (A-2) the word "**Service**" flashes. Now select the letter "**B**" with the adjusting dial (4). As a result, in the display "**RPM/RCF**" (A-1), the word "**ON/BEEP**" appears. After pressing the key "**RPM/RCF**" (5), you can turn the keyboard sound (On) or (Off) with the adjusting dial (4). (see figure 30). After you have stored the settings (see 4.1.2) you can change back to the normal program mode again by switch off the centrifuge for a short while.

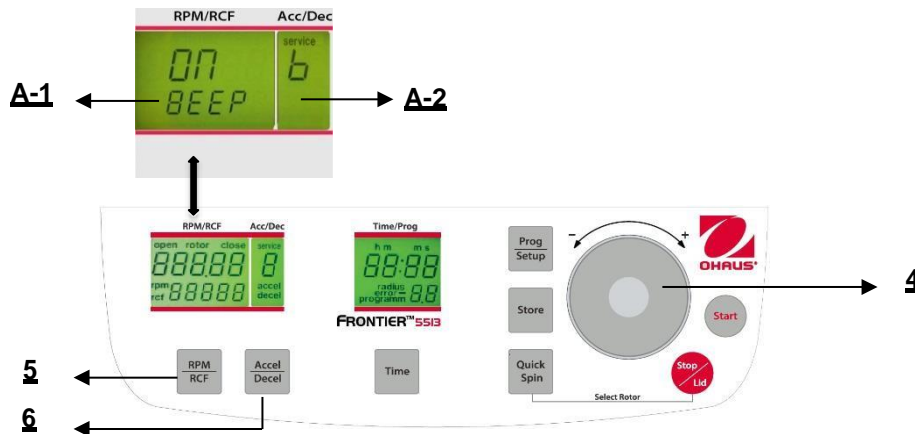

Figure. 30

4.1.5 Sleep Mode On / Off

After not using the centrifuge for 5 minutes, the display automatically switches off. By pressing any button, it switches on again. Proceed as illustrated, under point 1.8.2, to enter this program mode, press the key, "accel/decel" (5). In the display, "accel/decel" (A-2) flashes the word, "service". Select the letter "I" with the control field (1). As a result, appearing in the display, "rpm/rcf" (A-1), the word "SLEEP". After pressing the key, "rpm/rcf" (4), turn the sleep mode function (On) or (Off), with the rotary field (1).

After the settings have been stored by user, the normal program mode can be changed back again by switching off the centrifuge, for a short period.

4.1.6 Call up operating data



ATTENTION:

This should only be performed by advance user or service engineer.

In the mode "**Basic Adjustments**" you can call up the operating data of the centrifuge. Please proceed as described under point 4.1.2 to enter this program mode. Press the key "**Accel/Decel**" (6). In the display "**Acc/Dec**" (A-2) the word "**Service**" flashes.

With the adjusting dial (4) the different information can be accessed:

- A= previous starts of the centrifuge
- H= previous operating hours
- S= software version
- r= converter software
- E= list of previous error messages
- h= running time of the motor
- F= Function of the Imbalance Sensor
- P= Operation of Keyboard
- d= Hardware Version
- U= Intermediate Circuit Voltage in Volt

The list of the last 99 error messages can be looked over by pressing the key "**RPM/RCF**" (5) and scroll through it by the adjusting dial (4). The respective error codes appear in the display "**RPM/RCF**" (A-1). Please refer to "**Table 6: error messages**" (See APPENDIX).

To change back to normal program mode again, switch off the centrifuge for a short period.

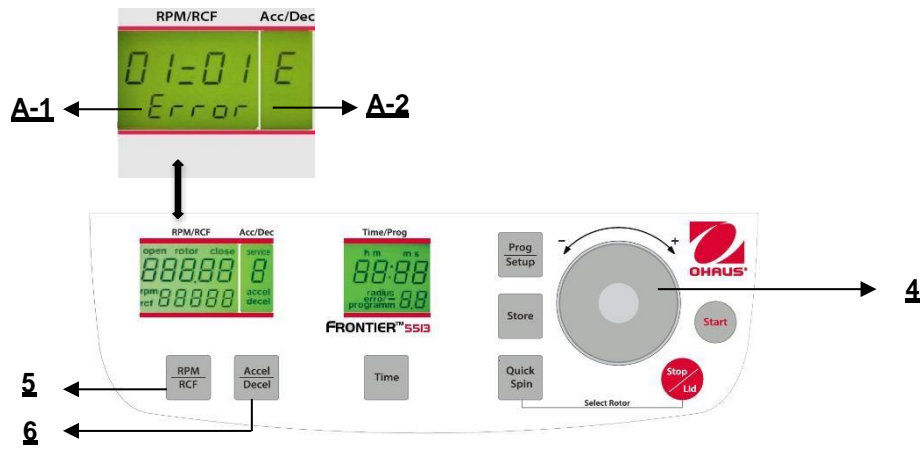

Figure. 33

5. MAINTENANCE

5.1 Maintenance and cleaning

5.1.1 General Care

Maintenance of the centrifuge is confined to keeping the rotor, the rotor chamber, and the rotor accessories clean as well as to regularly lubricating the rotor insert bolts of a swing out rotor (if available).

Lubricants containing molybde and graphite are not allowed.

Please pay special attention to anodized aluminum parts. Breakage of rotors can be caused even by slight damage. In case of rotors, buckets or tube racks getting in touch with corrosive substances the concerned spots have to be cleaned carefully.

Corrosive substances are for instance: alkalis, alkaline soap solutions, alkaline amines, concentrated acids, solutions containing heavy metals, water-free chlorinated solvents, saline solutions, e.g., salt water, phenol, halogenated hydrocarbons.



Cleaning – units, rotors, accessories

- Turn the device off and disconnect it from the power supply before you begin any cleaning or disinfecting. Do not pour liquids into the housing interior.
- Do not spray disinfectant on the device.
- Thorough cleaning not only has its purpose in hygiene but also in avoiding corrosion due to pollution.
- In order to avoid damaging anodized parts such as rotors, reduction plates etc., only pH-neutral Detergents with a pH-value of 6-8 may be used for cleaning. Alkaline cleaning agents (pH-value > 8) must not be used.
- After cleaning, please ensure all parts are dried thoroughly, either by hand or in a hot-air cabinet (max. Temperature + 50°C).
- It is necessary to coat anodized aluminum parts with anti-corrosion oil regularly in order to increase their life-spans and reduce corrosion predisposition.
- Due to humidity or not hermetically sealed samples, condensate may be formed. The condensate has to be removed from the rotor chamber with a soft cloth regularly.



The maintenance procedure has to be repeated every 10 to 15 runs, or at least once a week.

- Connect the unit to the power supply, after the equipment is completely dry.
- Do not carry out disinfection with UV-, beta- and gamma-rays or other high energy radiation.
- Metal rotors can be autoclaved.
- Rotor lid and adapters can also be autoclaved (max. 121°C, 20 min).
- The tube racks are made of PP and cannot be autoclaved at 134°C.

5.1.2 Cleaning and disinfection of the unit

1. Open the lid before you turn off the unit. Disconnect it from the power supply.
2. Open the rotor nut by turning the rotor key counterclockwise.
3. Remove the rotor.
4. For cleaning and disinfection of the unit and the rotor chamber use the above-mentioned cleaner.
5. Clean all accessible areas of the device and its accessories, including the power cord with a damp cloth.
6. Wash the rubber seals and rotor chamber thoroughly with water.
7. Rub the dry rubber seals with glycerol or talc to prevent these from becoming brittle. Other components of the unit, e.g. the lid lock, motor shaft and rotor must not be greased.
8. Dry the motor shaft with a soft, dry and lint-free cloth.
9. Control the unit and accessories for damage.

Make sure that the centrifuge is turned off the unit and disconnect the unit from the power supply. Then remove adherent dust from the ventilation slots in the centrifuge by using a soft brush. Do this at least every six months.

5.1.3 Cleaning and disinfection of the rotor

1. Clean and disinfect the rotors, rotor lids and adapters with the above-mentioned cleaner.
2. Use a bottle brush to clean and disinfect the rotor bores.
3. Rinse the rotors, rotor lid and adapter with clear water. Particularly the drillings of angle rotors.
4. For drying of the rotors and accessories set them on a towel. Place the angle rotors with bores down.
5. Dry the rotor cone with a soft, dry and lint-free cloth and look for damage. Do not grease the rotor cone.
6. Put the dry rotor back on the motor shaft.
7. Fix the rotor by turning the rotor nut clockwise.

5.1.4 Disinfection of aluminum rotors

In case of infectious material spilling into the centrifuge, the rotor and rotor chamber have to be disinfected directly after the run. Rotors may be autoclaved at a maximum temperature of 121°C.

5.1.5 Disinfection of PP-rotors

Autoclaving

During autoclaving, it's quite possible that plastic parts, e.g., rotor, can become deformed!
The recommended time for autoclaving: 15 – 20 min at 121°C (1 bar)

**ATTENTION:**

The sterilization time of 20 min. must not be exceeded. Repeated sterilization will cause reduction of the mechanical resistance of the plastic material.

Before autoclaving the PP-rotor and adapter must be thoroughly cleaned to avoid the burning in of dirty residues. You can disregard the consequences of some chemical residues to plastic materials at ambient temperatures. But at the high temperatures during autoclaving those residues may corrode and destroy the plastic. The objects must be thoroughly rinsed with distilled water after the cleaning but before the autoclaving. Residues of any cleaning liquids may cause fissures, whitening and stains.

Gas sterilization

Adapters, bottles and rotors may be gas sterilized with Ethylenoxyd. Make sure to air out the items after the sterilization and before using them again.

**ATTENTION:**

Because the temperature may rise during the sterilization, rotors, adapters and bottles must not be closed and must be totally unscrewed.

Chemical sterilization

Bottles, adapters and rotors may be treated with the usual liquid disinfectants.

**ATTENTION:**

Before applying any other cleaning or decontamination method than recommended by the manufacturer, contact the manufacturer to ensure that it will not damage the unit or the rotor.

5.1.6 Glass breakage

With high g-values, the rate of glass tube breakage increases. Glass splinters have to be removed immediately from rotor, buckets, adapters and the rotor chamber itself. Fine glass splinters will scratch and therefore damage the protective surface coating of a rotor. If glass splinters remain in the rotor chamber, fine metal dust will build up due to air circulation. This very fine, black metal dust will significantly pollute the rotor chamber, the rotor, the buckets and the samples.

If necessary, replace the adapters, tubes and accessories to avoid further damage. Check the rotor bores regularly for residues and damage.

**ATTENTION:**

Please check the relevant specifications of the tubes centrifuges with the manufacturer.

Lifetime of rotors, buckets, accessories

Rotors and rotor lid made of aluminum or stainless steel, have an operating time of max. 7 years from first use.

Transparent rotor lids and caps made of PC or PP as well as rotors, tube racks and adapters of PP have a maximum operating time up to 3 years from first use.

Condition for the operating time: Proper use damage-free condition, recommended care.

6. TROUBLESHOOTING

6.1 Error message: Cause / Solution

The error messages are listed to help localize possible errors faster.

The diagnosing referred to in this chapter may not always be the case, as they are only theoretically occurring errors and solutions.

Please keep us informed about any kind of error occurring, which is not listed in this chapter. Only through your information are we able to improve this operation manual.

Many thanks in advance for your support.

6.2 Survey of possible error messages and their solutions

6.2.1 Lid release during power failure (Emergency Lid Release)

In case of power failure or malfunction, the lid of the centrifuge can be opened manually in order to protect your samples.

Please proceed as follows:

1. Switch off the centrifuge and unplug the power cord, wait until the rotor has come to a standstill. (this may take several minutes)
2. On the left side of the centrifuge housing there is a plastic stopper (see figure 34). Remove this stopper. Fastened to it, is a string which is connected to the lid lock
3. Pull the string slightly and the lid will open.
4. Open the lid of the centrifuge.
5. Switch the centrifuge on again, to proceed with regular function.



ATTENTION:

- Don't put your hands in the rotor chamber as long as the rotor is still spinning!
- Push the plastic stopper back in the unit again, to continue working.
- FC5513R model has plastic stopper on the right side of the centrifuge.



Figure. 34-1

Figure. 34-2

Figure. 34-3

6.2.2 Description of the error message system

The error message "**error**" (M11) is shown in the "**Time/Prog**" (A-3) display (see figure 35). Detailed information about possible error messages are in "**table 6: error messages**" (See APPENDIX).

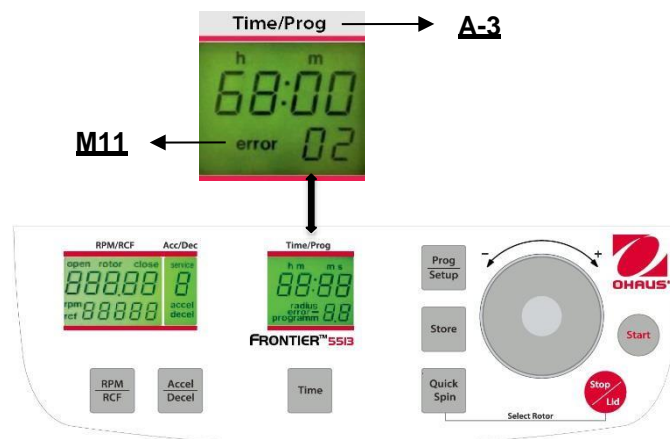

Figure. 35

7. RECEIPT OF CENTRIFUGES TO REPAIR



Health risk from contaminated equipment, rotors and accessories.

In case of returning the centrifuge for repairing to the manufacturer, please notice the following:

The centrifuge must be decontaminated and cleaned before the shipment for the protection of persons, environment, and material.

Decontamination certificate at goods return delivery (See APPENDIX)

We reserve the right to not accept contaminated centrifuges.

Further on all costs occurred for the cleaning and disinfection of the units will go to the debit of the customer's account.

8. TRANSPORT AND STORAGE

8.1 Transport

Before transporting, take out the rotor.

Only transport the unit in the original packaging.

Use a transport aid for transporting over longer distances to fix the motor shaft.

	Air temperature	rel. humidity	Air pressure
General transportation	-25 to 60 °C	10 to 75 %	30 to 106 kPa

8.2 Storage

During storage of the centrifuge the following environmental conditions must be observed

	Air temperature	rel. Humidity	Air pressure
in transport packaging	-25 to 55 °C	10 to 75 %	70 to 106 kPa

:

9. TECHNICAL DATA

9.1 Specifications

9.1.1 Centrifuge FC5513

Model	FC5513	
Speed Range	200 rpm -13500 rpm;10 rpm/set	
Maximum RCF	17317 x g;10 x g/set	
Maximum Capacity (Rotor)	24x1.5/2.0 ml	
Running Time	10 sec to 99 hr 99 min 59 sec or continuous	
Noise level (depending on the rotor)	≤60 dB(A)	
Allowable density at maximum speed	1.2 kg/dm ³	
Allowable kinetic energy	2129 Nm	
Mains power connection AC	230 V/~50-60 Hz	120 V/~50-60 Hz
Voltage fluctuation	± 10 %	± 10 %
Current consumption	1.05 A	1.9 A
Power consumption	170 W	170 W
Dimensions (W x D x H)	277 x 356 x 236 mm 10.9 x 14.0 x 9.3 in	
Net Weight (without rotor)	12.6 kg 27.8 lb	
Shipping Dimensions (W x D x H)	370 x 470 x 340 mm 14.6 x 18.5 x 13.4 in	
Shipping Weight (without rotor)	14.0 kg 30.9 lb	
Ambient conditions (EN/IEC 61010-1)		
Environment	for indoor use only	
Altitude	Use up to an altitude of 2000 m above MSL	
Ambient temperature	2°C up to 35°C	
Max. relative humidity	Max. relative humidity 80 % for temperatures up to 31°C, decreasing linearly to 50 % relative humidity up to 35°C.	
Overvoltage category (IEC 60364-4-443)	II	
Degree of contamination	2	
Class of protection	I	
Not suitable for use in hazardous environments.		
EMV Interference Emission, Noise Immunity	EN/IEC 61326-1 Class B emissions, Basic immunity FCC Class B emissions	

9.1.2 Centrifuge FC5513R

Model	FC5513R	
Speed Range	200 rpm -14500 rpm;10 rpm/set	
Maximum RCF	17157 x g;10 x g/set	
Maximum Capacity (Rotor)	24x1.5/2.0 ml	
Temperature range	-20° a 40 °C,1 °C/set	
Running Time	10 sec to 99 hr 99 min 59 sec or continuous	
Noise level (depending on the rotor)	≤56+2 dB(A)	
Allowable density at maximum speed	1.2 kg/dm3	
Allowable kinetic energy	2266 Nm	
Mains power connection AC	230 V/-50-60Hz	120 V/-50-60Hz
Voltage fluctation	± 10 %	± 10 %
Current consumption	1.8 A	1.9 A
Power consumption	320 W	320 W
Dimensions (W × D × H)	287 x 555 x 286 mm 11.3 x 21.9 x 11.3 in	
Net Weight (without rotor)	33 kg 73.0 lb	
Shipping Dimensions (W × D × H)	400 x 660 x 520 mm 15.7 x 26.0 x 20.5 in	
Shipping Weight (without rotor)	38 kg 83.5 lb	
Ambient conditions (EN/IEC 61010-1)		
Environment	for indoor use only	
Altitude	Use up to an altitude of 2000 m above MSL	
Ambient temperature	2°C up to 35°C	
Max. relative humidity	Max. relative humidity 80 % for temperatures up to 31°C,decreasing linearly to 50 % relative humidity up to 35°C.	
Overvoltage category (IEC 60364-4-443)	II	
Degree of contamination	2	
Class of protection	I	
Not suitable for use in hazardous environments.		
EMV Interference Emission, Noise Immunity	EN/IEC 61326-1 Class B emissions, Basic immunityFCC Class B emissions	

9.2 Drawings and dimensions

Dimensions for FC5513

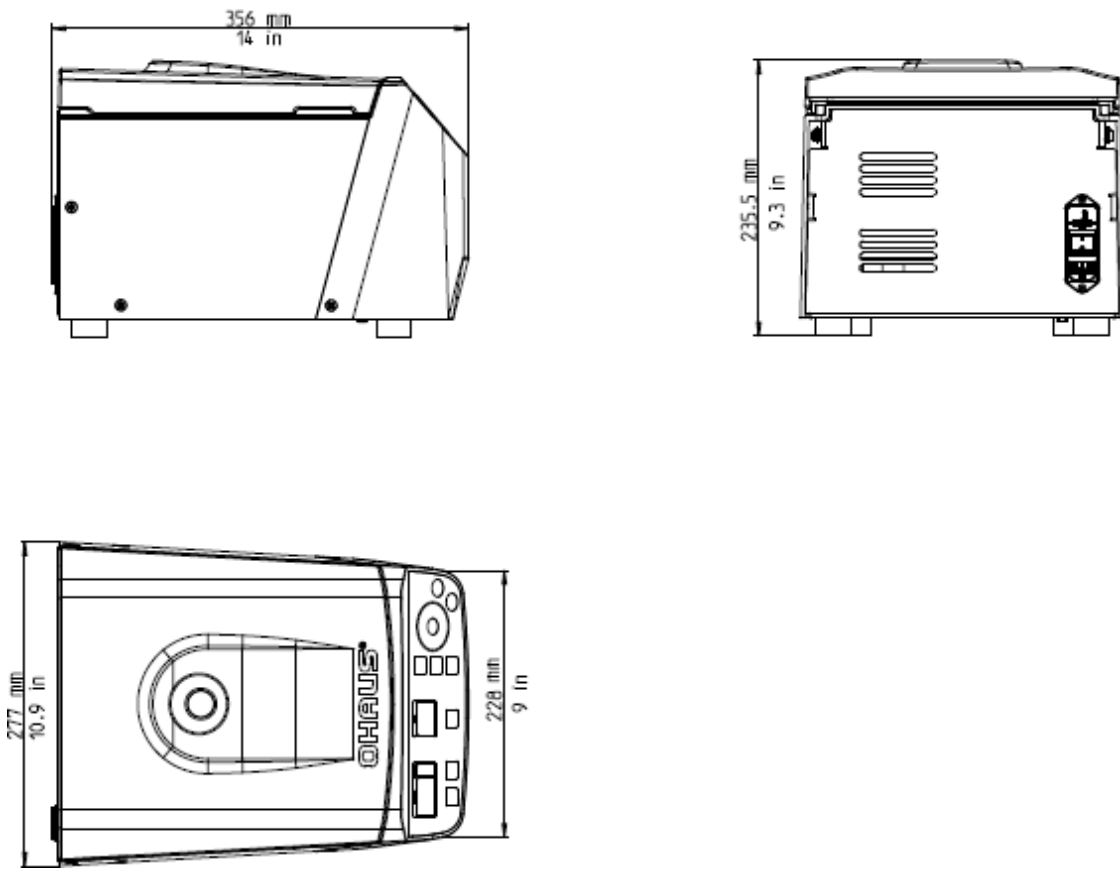

Dimensions for FC5513R

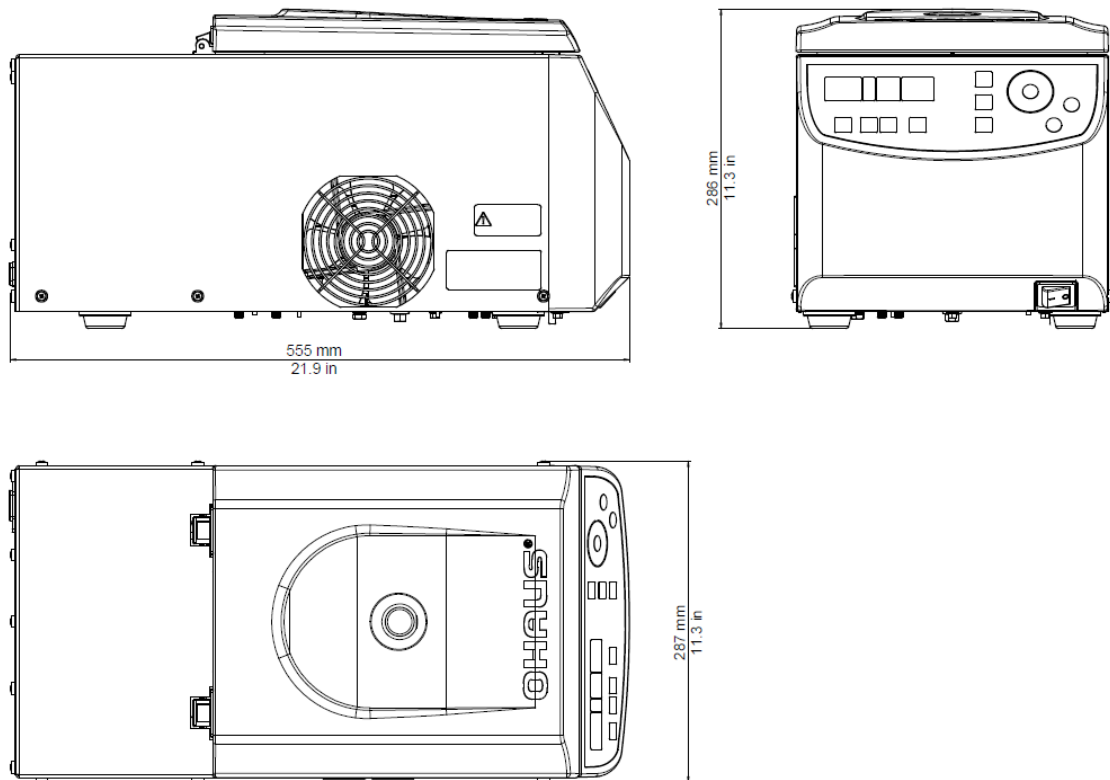

10. ORDER INFORMATION

Rotors

Rotor/Adapter	Description	Units
30472302	Rotor Angle 24x1.5/2.0ml BIOSEALS V1	1
30130885	Adapter 1x0.5ml D8ml 6/pk	6
30130884	Adapter 1x0.2/0.4ml D6mm 6/pk	6
30472304	Rotor Hematocrit 24xCapillaries V1	1
83041006	Rotor Angle 18x1.5/2.0ml Sealable	1
30130885	Adapter 1x0.5ml D8ml 6/pk	6
30130884	Adapter 1x0.2/0.4ml D6mm 6/pk	6
83041014	Rotor, Angle, 4x8-w PCR Strip, V1	1
30210898	Rotor Angle 24x2.0ml Spin Column	1

Notes: Packages are country specific and might vary. Please check the item number with the local OHAUS office before you order it.

11. COMPLIANCE

Compliance to the following standards is indicated by the corresponding mark on the product.

Marking	Standard
	This product conforms to the RoHS Directive 2011/65/EU, the EMC Directive 2014/30/EU and the Low Voltage Directive 2014/35/EU. The complete Declaration of Conformity is available online at www.ohaus.com/ce .

	<p>Disposal</p> <p>In conformance with the European Directive 2012/19/EU on Waste Electrical and Electronic Equipment (WEEE) this device may not be disposed of in domestic waste. This also applies to countries outside the EU, per their specific requirements. Please dispose of this product in accordance with local regulations at the collecting point specified for electrical and electronic equipment.</p> <p>If you have any questions, please contact the responsible authority or the distributor from which you purchased this device.</p> <p>Should this device be passed on to other parties (for private or professional use), the content of this regulation must also be related.</p> <p>For disposal instructions in Europe, refer to www.ohaus.com/weee.</p> <p>Thank you for your contribution to environmental protection.</p>
---	---

FCC Note

This equipment has been tested and found to comply with the limits for a Class B digital device, pursuant to Part 15 of the FCC Rules. These limits are designed to provide reasonable protection against harmful interference in a residential installation. This equipment generates, uses and can radiate radio frequency energy and, if not installed and used in accordance with the instructions, may cause harmful interference to radio communications. However, there is no guarantee that interference will not occur in a particular installation. If this equipment does cause harmful interference to radio or television reception, which can be determined by turning the equipment off and on, the user is encouraged to try to correct the interference by one or more of the following measures:

- Reorient or relocate the receiving antenna.
- Increase the separation between the equipment and receiver.
- Connect the equipment into an outlet on a circuit different from that to which the receiver is connected.
- Consult the dealer or an experienced radio/TV technician for help

12. APPENDIX

TABLE 1: PERMISSIBLE NET WEIGHT

TABLE 2: MAX. SPEED AND RCF-VALUES FOR PERMISSIBLE ROTORS

TABLE 3: LOWEST TEMPERATURES AT MAX.SPEED

TABLE 4: ACCELERATION AND DECELERATION TIMES

TABLE 5: ERROR MESSAGES

TABLE 6: RADIUS CORRECTION

TABLE 7: SYMBOLS- / ABBREVIATIONS

TABLE 8: REDEMPTION FORM / DECONTAMINATION CERTIFICATE

12.1 Table 1: Permissible net weight

Order No.	Capacity	Fit model	Max. speed	Permissible net weight
30472302	Rotor Angle 24x1.5/2.0ml BIOSEALS V1	FC5513	13500 rpm	82 g
		FC5513R	13000 rpm	82 g
30472304	Rotor Hematocrit 24xCapillaries V1	FC5513	13000 rpm	4.8 g
83041006	Rotor Angle 18x1.5/2.0ml Sealable	FC5513R	14500 rpm	62 g
83041014	Rotor Angle 4x8-w PCR Strip V1	FC5513	13500 rpm	14 g
		FC5513R	13000 rpm	14 g
30210898	Rotor Angle 24x2.0ml Spin Column	FC5513	13500 rpm	82 g

12.2 Table 2: Max. speed and RCF-values for permissible rotors

Order No.	Capacity	Fit model	Max. speed	RCF value
30472302	Rotor Angle 24x1.5/2.0ml BIOSEALS V1	FC5513	13500 rpm	17317 x g
		FC5513R	13000 rpm	16058 x g
30472304	Rotor Hematocrit 24xCapillaries V1	FC5513	13000 rpm	16058 x g
83041006	Rotor Angle 18x1.5/2.0ml Sealable	FC5513R	14500 rpm	17157 x g
83041014	Rotor Angle 4x8-w PCR Strip V1	FC5513	13500 rpm	14669 x g
		FC5513R	13000 rpm	13602 x g
30210898	Rotor Angle 24x2.0ml Spin Column	FC5513	13500 rpm	17317 x g

12.3 Table 3: Lowest temperatures at max. speed

Order No.	Capacity	Fit model	Max. speed	n-max
30472302	Rotor Angle 24x1.5/2.0ml BIOSEALS V1	FC5513	13500 rpm	N/A
		FC5513R	13000 rpm	0°C
30472304	Rotor Hematocrit 24xCapillaries V1	FC5513	13000 rpm	N/A
83041006	Rotor Angle 18x1.5/2.0ml Sealable	FC5513R	14500 rpm	0°C
83041014	Rotor Angle 4x8-w PCR Strip V1	FC5513	13500 rpm	N/A
		FC5513R	13000 rpm	0°C
30210898	Rotor Angle 24x2.0ml Spin Column	FC5513	13500 rpm	N/A

12.4 Table 4: Acceleration and deceleration times

FC5513

Order No.	Capacity	Acceleration values		Deceleration values	
		Stage 0	Stage 9	Stage 0	Stage 9
30472302	Rotor Angle 24x1.5/2.0ml BIOSEALS V1	108	15	116	13
30472304	Rotor Hematocrit 24xCapillaries V1	156	20	160	22
83041014	Rotor Angle 4x8-w PCR Strip V1	108	15	116	14
30210898	Rotor Angle 24x2.0ml Spin Column	136	19	171	18
in seconds					
Acceleration time from 0 min ⁻¹ -> U _{max}				Deceleration time from U _{max} -> 0 min ⁻¹	

FC5513R

Order No.	Capacity	Acceleration values		Deceleration values	
		Stage 0	Stage 9	Stage 0	Stage 9
30472302	Rotor Angle 24x1.5/2.0ml BIOSEALS V1	212	26	227	24
83041006	Rotor Angle 18x1.5/2.0ml Sealable	121	18	151	17
83041014	Rotor Angle 4x8-w PCR Strip V1	212	26	227	24
in seconds					
Acceleration time from 0 min ⁻¹ -> U _{max}				Deceleration time from U _{max} -> 0 min ⁻¹	

12.5 Table 4: Error messages

Error-No.	Description
1	Imbalance arose
2	Imbalance sensor is defective
11	Temperature sensor defective (only FC5513R)
12	Chamber over temperature (only FC5513R)
14	Leap of speed is too big between two measurements
CLOSE lid	
15	Standstill monitoring defective
16	Wrong direction of rotacion of the motor
18	Unit too warm
19	Drive overloaded, check if correct rotor is set
33	Open lid while motor is running
34	Lid contact defective
43	Undervoltage intermediate circuit voltage
44	Overvoltage intermediate circuit voltage
47	Overvoltage Motor
55	Overspeed
70	Timeout between controller and interface
80	Memory Error intern EEPROM
81	Memory failure
99	Rotor is not allowed for this program
FALSE	Inserted rotor does not exist in the program

12.6 Table 5: Radius correction

Rotor Order No.	Description	Adapter Order No.	Description	Radius (cm)	Correction (cm)
30472302	Rotor Angle 24x1.5/2.0ml BIOSEALS V1	None	None	8.5	0.0
		30130885	Adapter 1x0.5ml D8ml 6/pk	8.2	-0.3
		30130884	Adapter 1x0.2/0.4ml D6mm 6/pk	7.5	-1.0
83041006	Rotor Angle 18x1.5/2.0ml Sealable	None	None	7.3	0.0
		30130885	Adapter 1x0.5ml D8ml 6/pk	7.0	-0.3
		30130884	Adapter 1x0.2/0.4ml D6mm 6/pk	6.3	1.0

12.7 Table 6: Symbols- / Abbreviations

Symbol /	Unit	Description
n (=rpm)	[min ⁻¹]	revolutions per minute
RZB(=rcf)	[x g]	relative centrifugal force
PP	-	Polypropylen
PC	-	Polycarbonat
accel	-	acceleration
decel	-	deceleration
prog	-	program

Table 7: Redemption form / Decontamination certificate

Enclose this form with all returns of equipment and assemblies!

The completed declaration about the decontamination is a prerequisite for the assumption and further processing of the return. If no corresponding explanation is enclosed, we carry out decontamination with costs at your expense.

Please fill out in block capitals!

Surname; last name: _____

Organization / company: _____

Street: _____

ZIP CODE: _____ Place: _____

Telephone: _____ Fax: _____

E-Mail: _____

Pos.	Crowd	Decontaminated object	Serial number	Description / Comment
1				
2				
3				
4				

Are the parts listed above in contact with the following substances?

Health endangering watery solutions, buffers, acids, alkalis: _____ Yes No

Potentially infectious agents: _____ Yes No

Organic reagents and solvent: _____ Yes No

Radioactive substances: _____ α β γ _____ Yes No

Health endangering proteins: _____ Yes No

DNA: _____ Yes No

These substances have reached the equipment/assembly? _____ Yes No

Which one, if yes:

Description of the measures for the decontamination of the listed parts:

I confirm the proper decontamination:

Company/Dept. _____ Place and Date: _____

Signature of the authorized person n: _____